

ART - Arthroskopie

ART - Arthroscopy

Inhaltsverzeichnis

Seite

1	Inhaltsverzeichnis	
<u>2</u>	<u>Arthroskope und Trokarhülsen</u>	:
3	Endoskope für Arthroskopie 2,7 + 4 mm	
4	Endoskope für Arthroskopie Ø 1,7 mm	
5	Trokarhülsen, Trokare für Ø 1,7 mm	
6	Trokarhülsen, Trokare für Ø 4,0 mm	
7	Trokarhülsen, Trokare für Ø 2,7 mm	
<u>8</u>	<u>Stanzen, Scheren, Zangen</u>	:
9-11	Arthroskopie-Stanzen	
12	Arthroskopie-Scheren	
13-14	Arthroskopie-Zangen	
<u>15</u>	<u>Instrumente</u>	:
16-17	Handinstrumente	
18	Instrumente für 2. Einstich	
19-20	Spülkanülen	

Table of contents

Page

1	Index	
<u>2</u>	<u>Arthroscopes and Trocar sheaths</u>	:
3	Endoscopes for Arthroscopy 2,7 + 4 mm	
4	Endoscopes for Arthroscopy Ø 1,7 mm	
5	Trocar sheaths, Trocars for Ø 1,7 mm	
6	Trocar sheaths, Trocars for Ø 4,0 mm	
7	Trocar sheaths, Trocars for Ø 2,7 mm	
<u>8</u>	<u>Punches, Scissors, Forceps</u>	:
9-11	Arthroscopy-Punches	
12	Arthroscopy-Scissors	
13-14	Arthroscopy-Forceps	
<u>15</u>	<u>Instruments</u>	:
16-17	Hand instruments	
18	Instruments for 2 nd puncture	
19-20	Irrigation cannulas	

Endoskope für Arthroskopie Endoscopes for Arthroscopy

Verriegelung kompatibel zu Storz-Schäften / Connection compatible to Storz sheaths

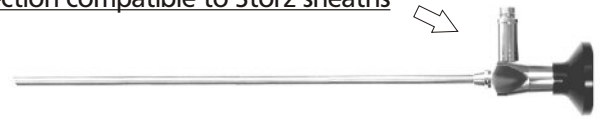

Ø 4 mm, Arbeitslänge 175 mm, autoklavierbar / Ø 4 mm, working length 175 mm, autoclavable

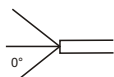

Geradeausblick
 Direct vision

0°

500.0400.A

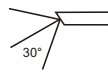

Vorausblick
 Foroblique vision

30°

500.0430.A

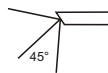

Vorausblick
 Foroblique vision

45°

500.0445.A

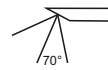

Seitblick
 Lateral vision

70°

500.0470.A



Ø 2,7 mm, autoclavable

L 110 mm

L 175 mm

L 187,5 mm

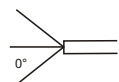

0°

501.2700.A

500.2700.A

502.2700.A

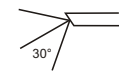

30°

501.2730.A

500.2730.A

502.2730.A



70°

501.2770.A

500.2770.A

502.2770.A

Verriegelung kompatibel zu Wolf-Schäften / Connection compatible to Wolf sheaths

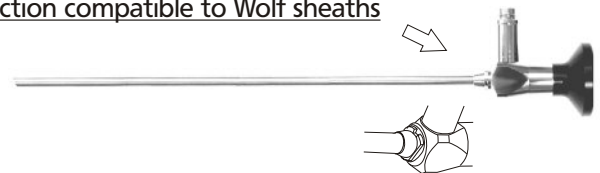

Ø 4 mm, Arbeitslänge 175 mm, autoklavierbar / Ø 4 mm, working length 175 mm, autoclavable



Vorausblick
 Foroblique vision

25°

500.0425.A

Endoskope für Arthroskopie Endoscopes for Arthroscopy

Ø 1,7 mm

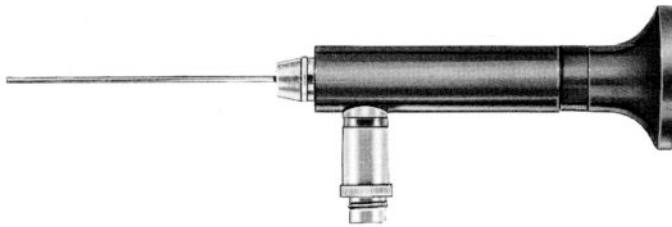

**Arthroskopie-Optiken für kleine Gelenke mit
Fiberglas-Lichtleitung, 1,7 mm Ø**

**Arthroscopes for small joints with fiber-light-guide,
1,7 mm Ø**

**Geradeausblick 0°
Direct vision 0°**

Nutzlänge/working length

60 mm

500.1700

110 mm

500.1700-

**Vorausblick 15°
Foroblique vision 15°**

Nutzlänge/working length

60 mm

500.1715

110 mm

500.1715-

Trokarhülsen für Optiken mit Trocar sleeves for scopes with

Ø 1,7 mm

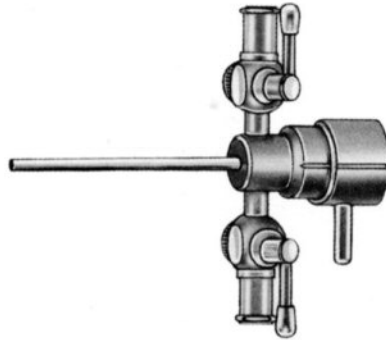

**Trokar-Hülse, ein Spülhahn mit LL Adapter, fest,
2,3 mm Ø**

Trocar sleeve, one stop cock with LL adapter, fixed, 2,3 mm Ø

passend zu/suitable to

500.1700 + 500.1715

500.1700 L + 500.1715 L

510.1701

510.1701 L

**Trokar-Hülse, zwei Spülhähne mit LL Adapter, drehbar, 2,3
mm Ø**

Trocar sleeve, two stop cocks with LL adapter, rotating,
2,3 mm Ø

passend zu/suitable to

500.1700 + 500.1715

500.1700 L + 500.1715 L

510.1721

510.1721 L



Obturator scharf, 1,9 mm Ø
Oburator sharp, 1,9 mm Ø

passend zu/suitable to

510.1701 + 510.1721

510.1701 L + 510.1721 L

510.1703

510.1703 L



Obturator stumpf, 1,9 mm Ø
Oburator blunt, 1,9 mm Ø

passend zu/suitable to

510.1701 + 510.1721

510.1701 L + 510.1721 L

510.1705

510.1705 L

Trokarhülsen für Endoskope mit Ø 4 mm Trocar sleeves for endoscopes with Ø 4 mm

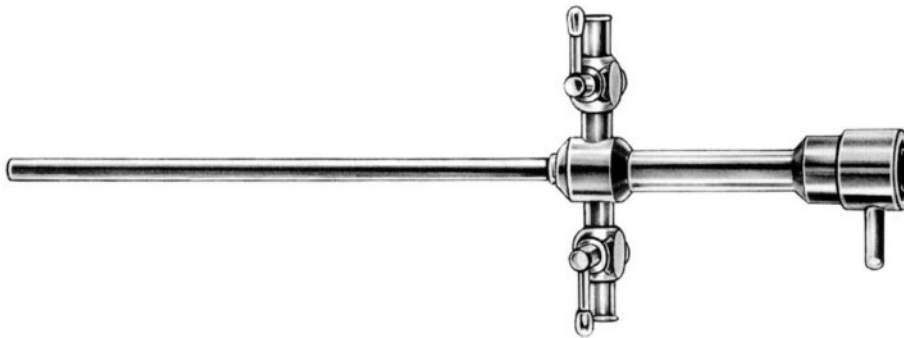

Trokar-Hülse, ein Spülhahn fest, 5,5 mm Ø
Trocar sleeve, one stop cock fixed, 5,5 mm Ø

510.0402

Trokar-Hülse, zwei Spülhähne fest, 5,5 mm Ø
Trocar sleeve, two stop cocks fixed, 5,5 mm Ø

510.0401

Trokar-Hülse, mit einem Spülhahn drehbar, 5,5 mm Ø
Trocar sleeve, with one stop cock rotating, 5,5 mm Ø

510.0422

Trokar-Hülse, mit zwei Spülhähnen drehbar, 5,5 mm Ø
Trocar sleeve, with two stop cocks rotating, 5,5 mm Ø

510.0421



Obturator scharf, 4,5 mm Ø
Obturator, sharp, 4,5 mm Ø

510.0403



Obturator stumpf, 4,5 mm Ø
Obturator, blunt, 4,5 mm Ø

510.0405

Trokarhülsen für Endoskope mit Ø 2,7 mm Trocar sleeves for endoscopes with Ø 2,7 mm

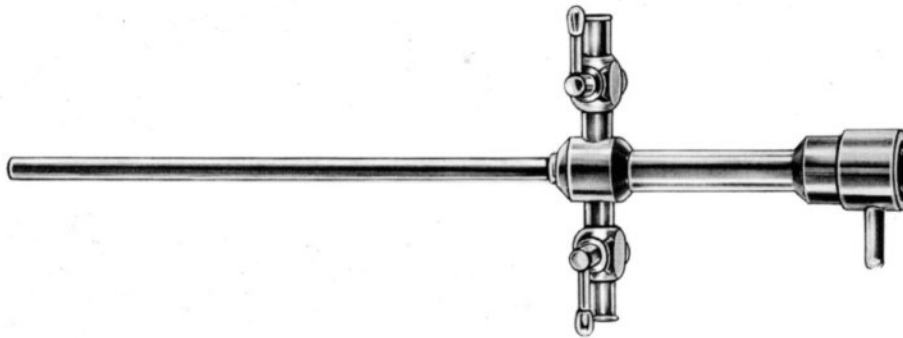

Trokar-Hülse, ein Spülhahn fest, 4 mm Ø
Trocar sleeve, one stop cock fixed, 4 mm Ø

510.2702

Trokar-Hülse, zwei Spülhähne fest, 4 mm Ø
Trocar sleeve, two stop cocks fixed, 4 mm Ø

510.2701

Trokar-Hülse, mit einem Spülhahn drehbar, 4 mm Ø
Trocar sleeve, with one stop cock rotating, 4 mm Ø

510.2722

Trokar-Hülse, mit zwei Spülhähnen drehbar, 4 mm Ø
Trocar sleeve, with two stop cocks rotating, 4 mm Ø

510.2721



Obturator scharf, 3,4 mm Ø
Obturator sharp, 3,4 mm Ø

510.2703



Obturator stumpf, 3,4 mm Ø
Obturator blunt, 3,4 mm Ø

510.2705

Arthroskopie-Stanzen Arthroscopy punches

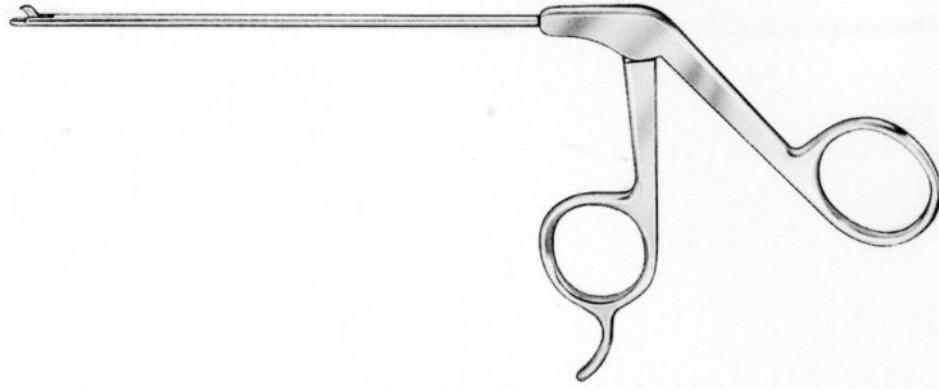

Hakenstanze, mit Schippe
 Hook punch, scoop nose

3,5 mm Ø

2,7 mm Ø

gerade – straight

541.3101

541.2101

Im Schaft gebogen/shaft curved:



rechts – right 30°

541.3102

541.2102



links – left 30°

541.3104

541.2104

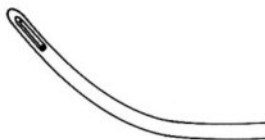

rechts – right 45°

541.3103

541.2103

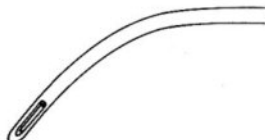

links – left 45°

541.3105

541.2105



aufwärts – upward 7°

541.3106

541.2106



abwärts – downward 7°

541.3108

541.2108



aufwärts – upward 15°

541.3107

541.2107



abwärts – downward 15°

541.3109

541.2109

Arthroskopie-Stanzen

Arthroscopy punches

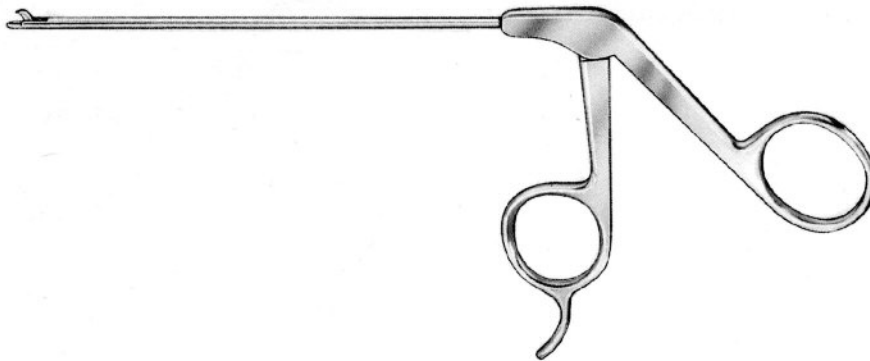

Hakenstanze, stumpf
 Hook punch, blunt nose

3,5 mm Ø

2,7 mm Ø

gerade – straight

541.3201

541.2201

Im Schaft gebogen/shaft curved:



rechts – right 30°

541.3202

541.2202



links – left 30°

541.3204

541.2204



rechts – right 45°

541.3203

541.2203



links – left 45°

541.3205

541.2205



aufwärts – upward 7°

541.3206

541.2206



abwärts – downward 7°

541.3208

541.2208



aufwärts – upward 15°

541.3207

541.2207



abwärts – downward 15°

541.3209

541.2209

Arthroskopie-Stanzen Arthroscopy punches

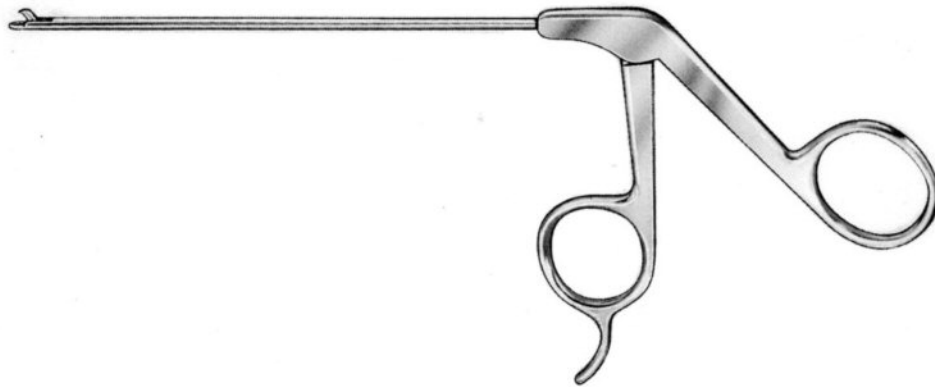

Biopsie-Stanze, seitlich schneidend 3,4 mm Ø
 Biopsy punch, side-biter 3,4 mm Ø

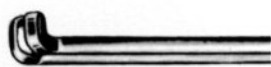

Maulteil gewinkelt/jaw curved:

90°



rechts - right 90°

541.3321



links - left 90°

541.3323

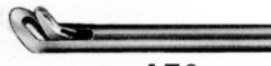

45°



rechts - right 45°

541.3322



links - left 45°

541.3324



Probeexzisions-Stanze, gerade
 Biopsy punch, straight

541.3630



Probeexzisions-Stanze, 90 Grad rechts
 Biopsy punch, curved 90° to the right

541.3631



Probeexzisions-Stanze, 90 Grad links
 Biopsy punch, curved 90° to the left

541.3632

Breitmaulstanzen - Wide square jaw

Arthroskopie-Scheren Arthroscopy scissors

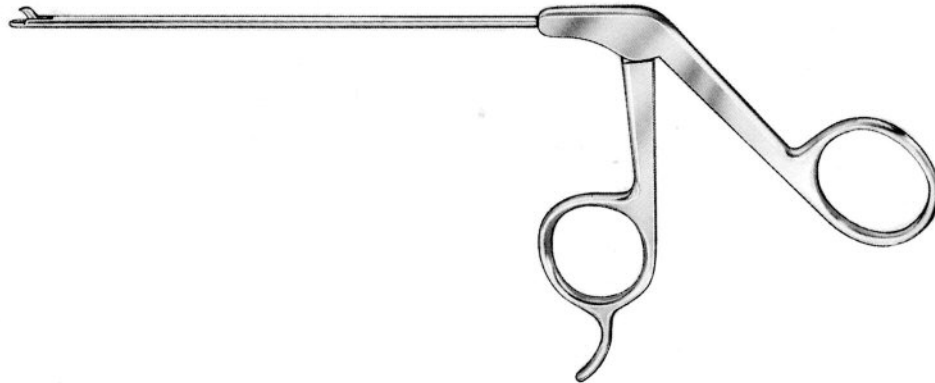

Hakenschere 3,5 mm Ø
 Hook scissors 3,5 mm Ø

gerade – straight

541.3401

im Schaft gebogen/shaft curved:



rechts – right 30°

541.3402



links – left 30°

541.3404



rechts – right 45°

541.3403



links – left 45°

541.3405

Maulteil gewinkelt/jaw curved



rechts – right

541.3413

45°



links – left

541.3415

45°

Arthroskopie-Zangen Arthroscopy forceps

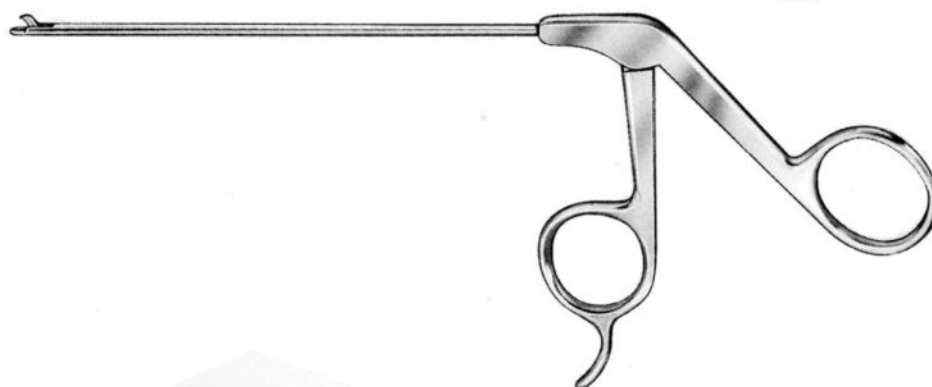

Greif-Zange
Grasping forceps

541.3501

Greif-Zange mit Sperre
Grasping forceps, w. ratchet

541.3502

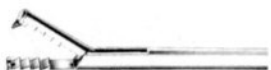

Faß-Zange, mit Mauszahn, 3,5 mm Ø
Grasping forceps w. mouse-teeth, 3,5 mm Ø

541.3503

Faß-Zange, Mauszahn und Sperre, 3,5 mm Ø
Grasping forceps with mouse-teeth and ratchet

541.3504



Faß- und Biopsie-Zange, 3,5 mm Ø
Grasping and biopsy forceps, 3,5 mm Ø

541.3507

Faß- und Biopsie-Zange mit Sperre, 3,5 mm Ø
Grasping and biopsy forceps with ratchet, 3,5 mm Ø

541.3508

Arthroskopie-Zangen Arthroscopy forceps



Meniskus-Faßzange kräftig, 4,2 mm Ø
Meniscus grasping forceps, strong, 4,2 mm Ø

545.3507

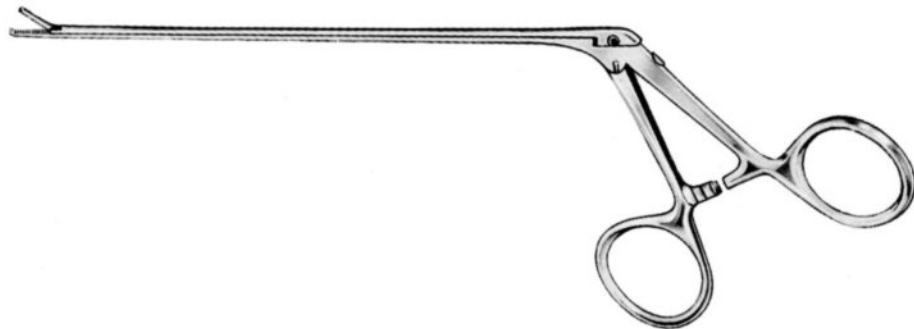

Mini-Faß-Zange mit Mauszahn und Sperre, 2,2 mm Ø
Mini grasper with mouse-teeth and ratchet, 2,2 mm Ø

545.2503

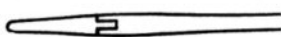
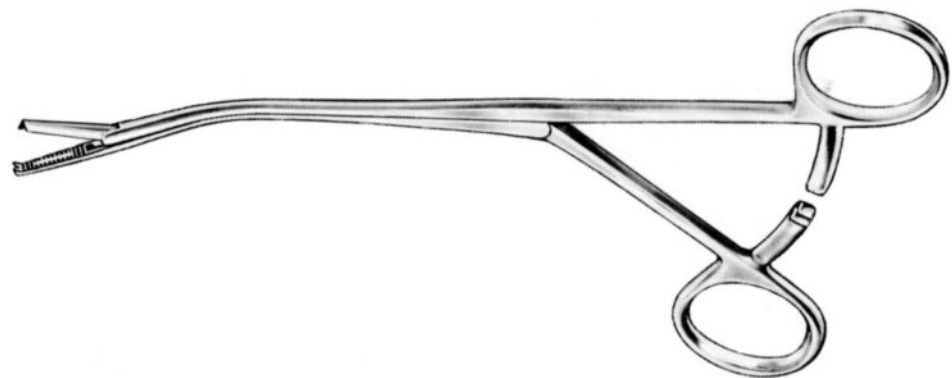

Meniskusretraktor gerade mit Mauszahn und Sperre
Meniscus retractor straight with mouse teeth and ratchet

545.3511



rechts - right 30°

545.3512



links - left 30°

545.3513

Hand-Instrumente Hand instruments

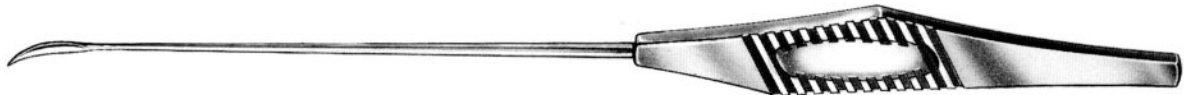

Hakensonde graduiert
Hook probe graduated
3 mm
5 mm

530.4001
530.4013



Messer spitz
Traditional knife, sharp

530.4002



Hakenmesser
Hook knife

530.4003



Messer retrograd
Knife, retrograde

530.4004

Banana-Messer
Banana knife



glatt/smooth
gezahnt/serrated

530.4005



530.4006



Rosettenmesser
Rosette knife

530.4007

Hand-Instrumente Hand instruments



Meniskotom nach Smillie
Smillie knife
3 mm
5 mm

530.4009
530.4008



Messer sichelförmig
Sickle knife

530.4010



Löffel 3 mm Ø
Spoon 3 mm Ø

530.4011



Ring-Kürette, 3 mm Ø
Ring curette, 3 mm Ø

530.4012

Instrumente für 2. Einstich Instruments for 2. puncture

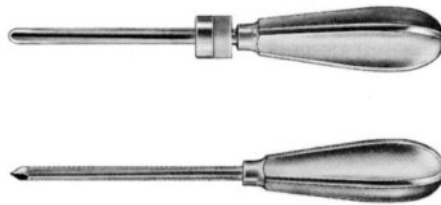

Trocarhülle mit scharfem und stumpfem Obturator, 2,5 mm Ø
Trocar sleeve with sharp and blunt obturator, 2,5 mm Ø

510.2501

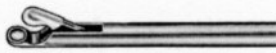
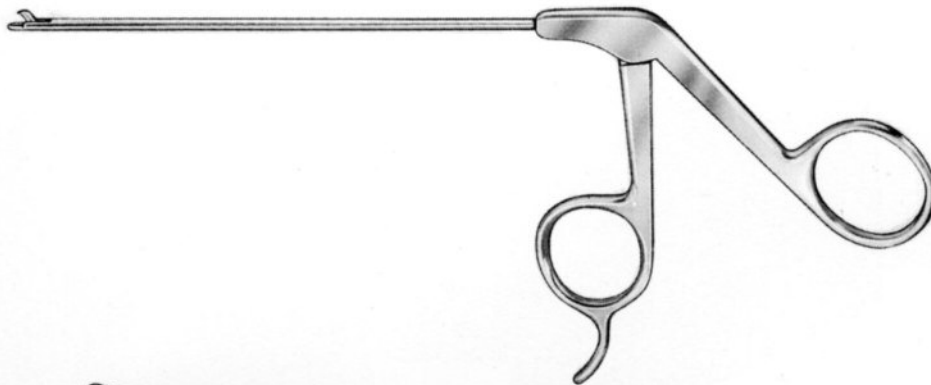

Zange mit Doppellöffel, 2 mm Ø
Forceps with double-spoon, 2 mm Ø

541.2011

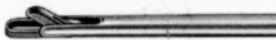

Zange durchschneidend, 2 mm Ø
Forceps cutting through, 2 mm Ø

541.2012



Schere, 2 mm Ø
Scissors, 2 mm Ø

541.2013

Spülkanüle Irrigation cannula

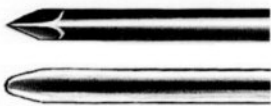

Spülkanüle m. LL-Ansatz, 4,5 mm Ø, 8,5 cm lang
mit scharfem und stumpfem Obturator

510.0437

Irrigation cannula, LL-connection 4,5 mm Ø, 8,5 cm, with
sharp and blunt obturator



Spülkanüle mit 2 seitlichen Löchern, LL-Anschluß
4,5 mm Ø, 8,5 cm lang, mit scharfem und stumpfem
Obturator

510.0439

Irrigation cannula with 2 holes, LL-connection 4,5 mm Ø,
8,5 cm, with sharp and blunt obturator



Spüladapter mit Schlaucholive
Irrigation Adapter w. tube connection

510.0441

Spülkanüle Irrigation cannula



Kanüle zur Spülung, LL-Anschluß, 2,2 mm Ø, 7 cm lang
Cannula for irrigation, LL-connection, 2,2 mm Ø,
7 cm length

510.0430



**Kanüle für Spülung mit scharfem Obturator,
LL-Anschluß, 3,2 mm Ø, 7 cm lang**
Cannula for irrigation with sharp obturator, LL-connection,
3,2 mm Ø, 7 cm length

510.0431



**Kanüle für Spülung mit Hahn, scharfem Obturator,
LL-Ansatz, 7 cm lang**
Cannula for irrigation w. stop cock and sharp obturator,
LL-connection, 7 cm length
3,2 mm Ø
4,5 mm Ø

510.0432
510.0433